

- <sup>ぶんどき</sup>分度器の中心を点アに合わせて次の角度をかきましょう。

1 75°

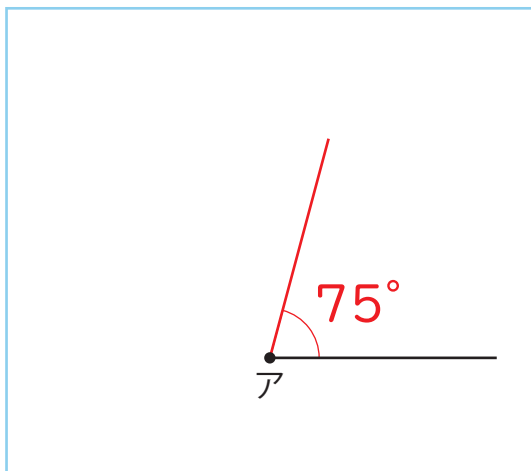

2 175°

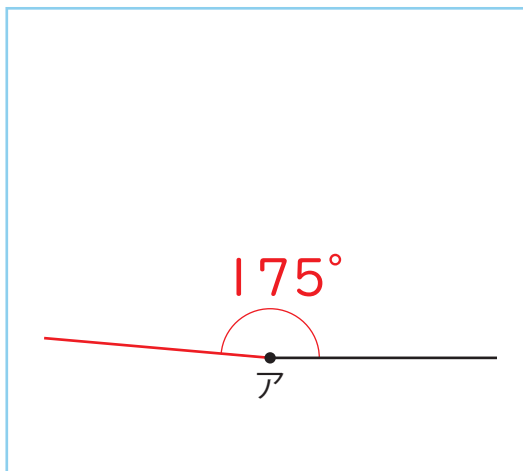

3 60°

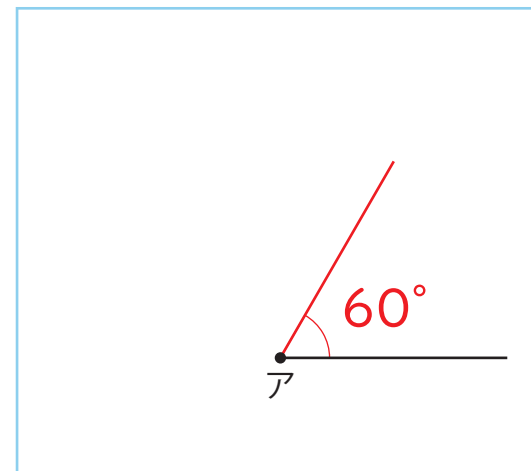

4 95°

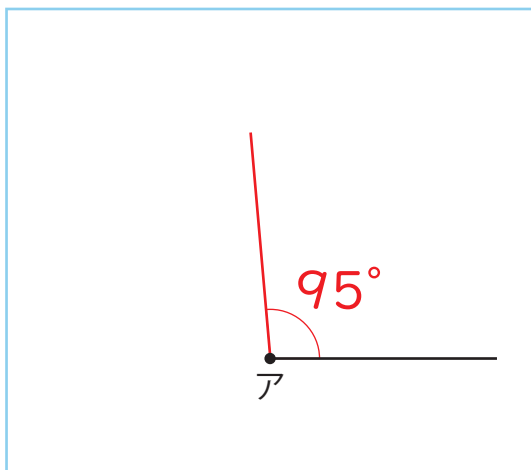

5 145°

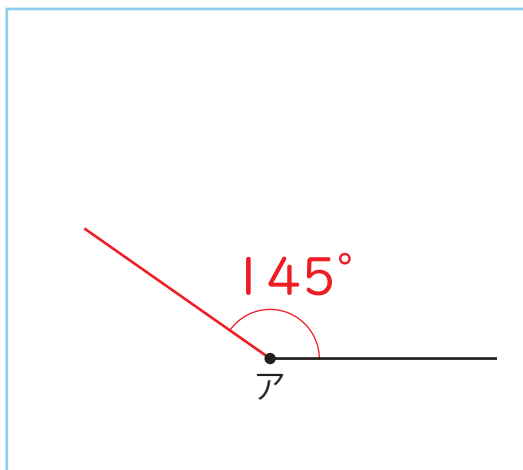

6 115°

